

Data Sheet



Article number: 03556090

Description: Fluro hydraulic rod end FS 90N

Measures

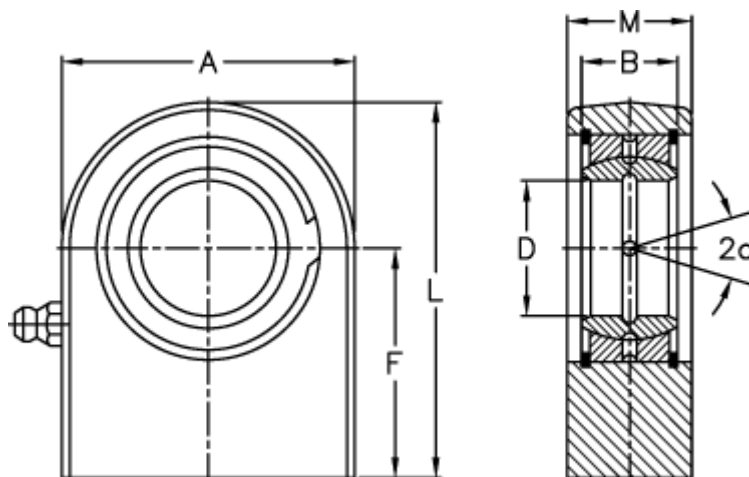

A	= 226	Static load C0 (kN) = 1340
a (degrees)	= 5	Weight = 23400
B	= 60	
D	= 90	
Dynamic load C (kN)	= 490	
F	= 150	
L	= 263	
M	= 65	